

Product Details

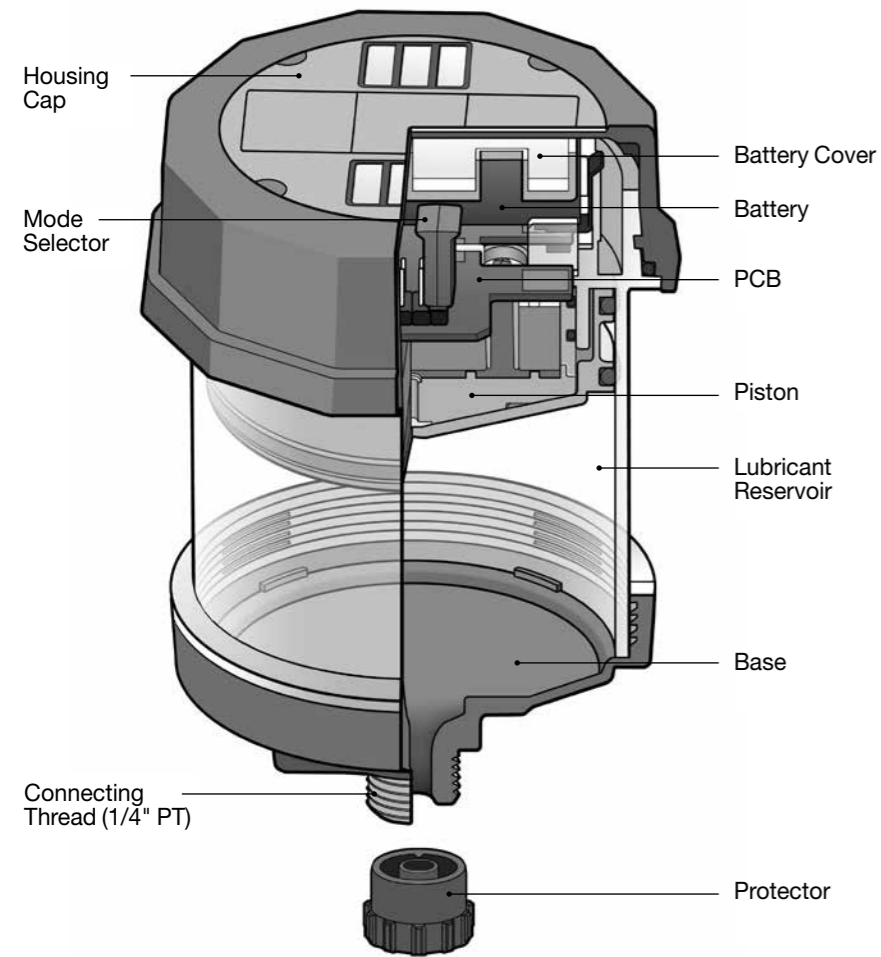

Installation/Disposal Guidelines

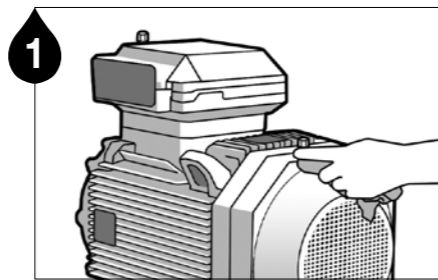

1 Remove contaminants around the lube point.

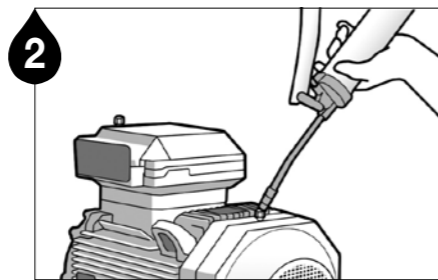

2 Ensure a clear passage using a manual grease gun. **Note 1** Remove any hardened grease by purging the lube point with a manual grease gun. **Note 2** The grease in the equipment and the grease contained in the unit should be the same or compatible.

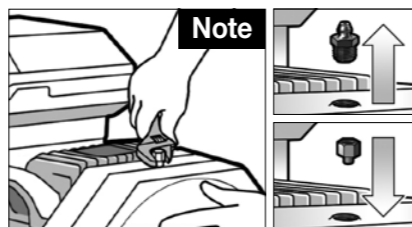

Note Remove the grease nipple and install appropriate adaptors.

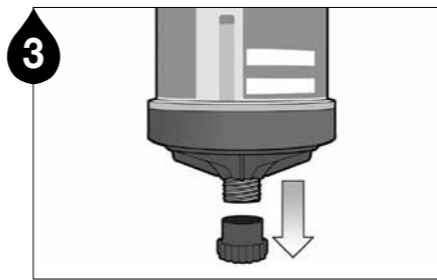

3 Remove the protector.

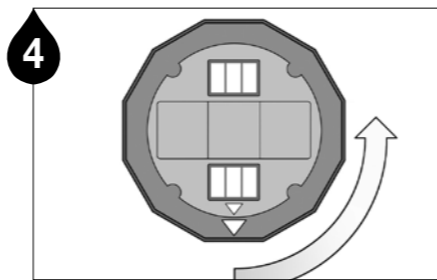

4 Turn the housing cap counterclockwise and unscrew the cap.

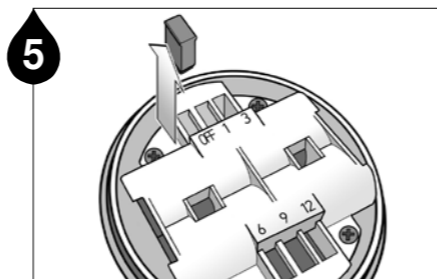

5 Pull out the red Mode Selector from the default OFF position.

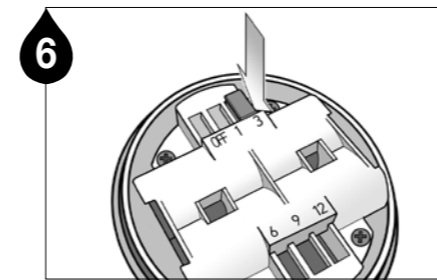

6 Firmly push the Mode Selector into the slot of the desired period.

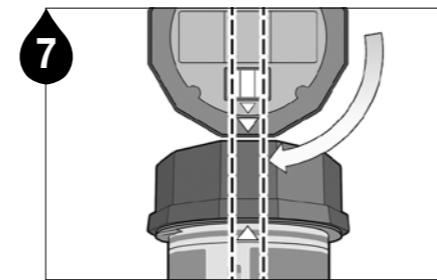

7 To position the window properly, align the ▼ on the housing cap with the ▼ on the body.

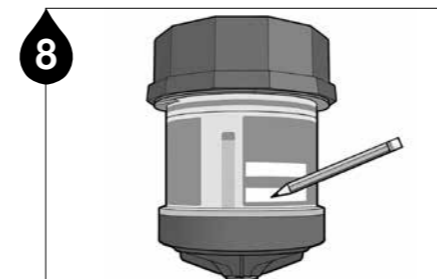

8 Note the installation date and the scheduled date of lube cycle completion on the label of the Pulsarlube E. **Note** Please note there is a delay before the actual dispensing starts. It may take up to 1-3 weeks for enough gas to be formed depending on the dispensing setting & installation condition.

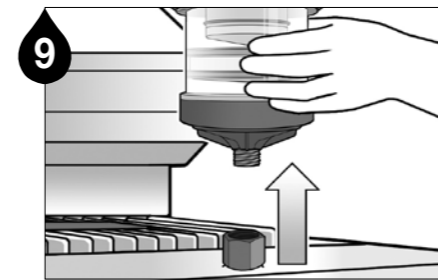

9 When the selected dispensing period of the Pulsarlube E has completed, remove the lubricator from the application.



10 The Pulsarlube E is an eco-friendly product that can be disposed of separately. Turn the housing cap counterclockwise to disassemble the product for proper disposal.

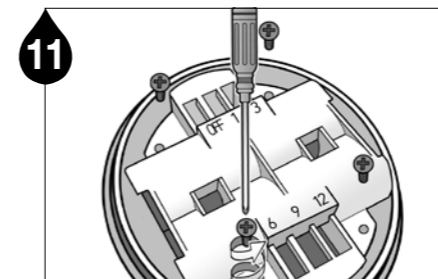

11 Unscrew the screws to remove the battery cover.

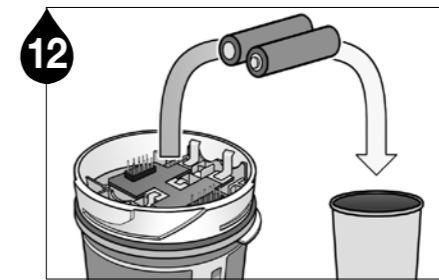

12 Remove the batteries.

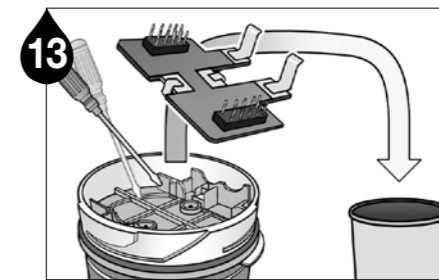

13 Using a hand tool such as a flat-head screwdriver, detach the PCB from the unit.

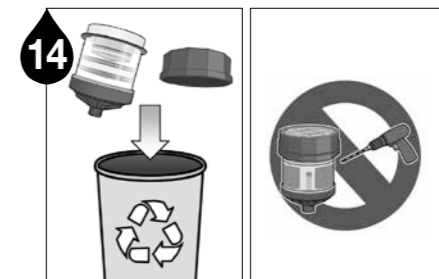

14 Dispose of remaining plastic components complying with local regulations for recycling. **Warning** Do not cut, puncture, or reuse lubricator.

Mounting Installations

High backpressure can cause a delay in dispensing (must be under 5 bar).

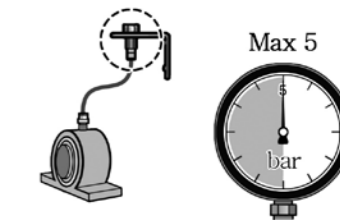

If the product is installed at a 45° or 90° angle, please use an angle adapter with a diameter greater than or equal to 1/4".

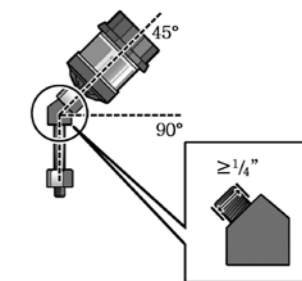

For remote installation using an 8mm O.D. tubing, keep the maximum distance at 1m (3ft) or less.

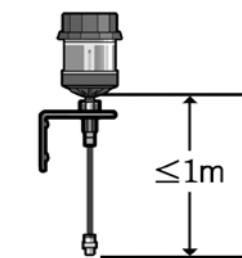

Pulsarlube E Standard Lubricants

Grease	Grease Type	Description
PL1	Multi Purpose	High performance multipurpose lubricant
PL2	Heavy Duty	Excellent extreme pressure lubricant containing solid lubricants
PL3	High Speed	Superior high speed (over 3,000 rpm) or high DN lubricant
PL4	H1 Food Grade	NSF H1 registered food grade lubricant
PL5	High Temperature	High oxidation stability lubricant
PL6	Multi Purpose with MoS ₂	Multipurpose lubricant fortified with extreme pressure additives and MoS ₂
PL7	Low Temperature	Synthetic lubricant for extreme low temp applications (below 15°C)
PL10	Electric Motor Bearing	High vibration-resistance lubricant

Note OEM filling is available upon request under special terms and conditions. Please contact your local distributor for more information.

Dispensing Volume Chart

Dispensing Period	Dispensing Volume		
	60ml	120ml	240ml
1 month	2.00ml/day	4.00ml/day	8.00ml/day
3 month	0.67ml/day	1.33ml/day	2.66ml/day
6 month	0.33ml/day	0.67ml/day	1.33ml/day
9 month	0.22ml/day	0.44ml/day	0.89ml/day
12 month	0.17ml/day	0.33ml/day	0.67ml/day

Note Dispensing volumes (ml/day) are calculated assuming the lubricator is operating at 1 atm (14.7 psi), 20°C. Output volume may vary with ambient temperature changes, atmospheric pressure changes, consistency of lubricant, or any resistance or backpressure existing at the lube point (bearing or passage).

Shelf life and Product Warranty The shelf life of the Pulsarlube E unit is 1 year from the date of production. Product warranty is limited to original defects in material and workmanship and will not cover any collateral damage due to mishandling, abuse and/or any other inappropriate use of this product. Warranty period is 1 year from the date of purchase.

Warning This product is a disposable unit. Please replace with a new unit once set dispensing period has completed.

Product Certifications

Certifications		
IECEX	Ex ia IIC T4 Ga IECEX KTL 12.0008X -20°C ≤ Ta ≤ +55°C	IEC 60079-0:2007-10 IEC 60079-11:2006
ATEX	CE 0344 II 1 G Ex ia IIC T4 Ga INERIS 12ATEX0062X -20°C ≤ Ta ≤ +55°C	EN 60079-0:2009 EN 60079-11:2007 EN 60079-26:2007
KCs	Ex ia IIC T4 12-KB2B0-0283X -20°C ≤ Ta ≤ +55°C	IP68
UL	UL US LISTED E352761	Class I, Div. I, Group A, B, C, D Class II, Div. I, Group E, F, G

Warning

- ▶ Locations: Intrinsically Safe, SÉCURITÉ INTRINSÈQUE Exia
- ▶ Potential electrostatic charging hazard; clean only with a damp cloth
- ▶ Do not charge, replace, or charge battery cells
- ▶ Temp Code T4: -25°C ≤ Ta ≤ +55°C
- ▶ Substitution of components may impair Intrinsic Safety: AVERTISSEMENT: LA SUBSTITUTION DE COMPOSANTS PEUT COMPROMETTRE LA SÉCURITÉ INTRINSÈQUE
- ▶ If ignitable gasses are present, touch only with an insulating object or while wearing an electrostatic grounding device
- ▶ To prevent ignition of flammable or combustible atmospheres, read, understand, and adhere to manufacturer's live maintenance procedure.

Mounting Methods

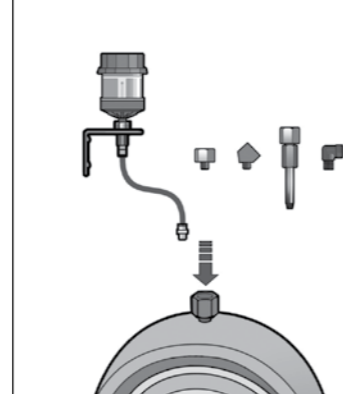

The Pulsarlube E is designed for single point lubrication only. Direct mount is always preferable. For applications not allowing any direct mounts, remotely mount the unit using appropriate accessories and keep the distance from the lube point as short as possible.

For remote installation using a tube, use an 8mm O.D. (5/16") tubing pre-filled with the same or compatible grease as the grease contained in the unit.

Rev.02

PULSARLUBE

The World Leader of Automatic Lubrication

Pulsarlube USA, Inc.

1480 Howard Street, Elk Grove Village, IL 60007, USA
TEL: 1-847-593-5300 FAX: 1-847-593-5303 www.pulsarlube.com / info@pulsarlube.com

